



At the heart of the image™

D800TM



75
million
NIKKOR



• Lens: AF-S NIKKOR 14-24mm
f/2.8G ED
• Exposure: [M] mode,
1 second, f/8
• White balance: Color
temperature (5,000 K)
• Sensitivity: ISO 100
• Picture Control: Standard
©Benjamin Antony Morn
Bibliothèque nationale de France



- Lens: AF-S NIKKOR 70-200mm f/2.8G ED VR II
- Exposure: [M] mode, 1/200 second, f/4.5
- White balance: Auto 2
- Sensitivity: ISO 640
- Picture Control: Portrait

©Cliff Mautner



• Lens: AF-S NIKKOR
70-200mm f/2.8G ED VR II
• Exposure: [A] mode,
1/15 second, f/8
• White balance: Auto 1
• Sensitivity: ISO 100
• Picture Control: Landscape
©Jim Brandenburg



- Lens: AF-S NIKKOR 200mm f/2.8G ED VR II
- Exposure: [M] mode, 1/200 second, f/10
- White balance: Color temperature (5,500 K)
- Sensitivity: ISO 100
- Picture Control: Portrait

©Rob Van Petten



- Lens: AF-S VR Micro-Nikkor 105mm f/2.8G IF-ED
- Exposure: [A] mode, 1/500 second, f/8
- White balance: Auto 1
- Sensitivity: ISO 400
- Picture Control: Standard

©Jim Brandenburg

MINUSCULE DETAILS, MONUMENTAL IMAGES, BROADCAST QUALITY VIDEOS



What does it take to render images perfectly? Sharp resolution? Subtle textures? Color fidelity? Tones so nuanced that the viewer wants to reach out and touch them? All of this is possible with the D800, Nikon's newest FX-format D-SLR. Its groundbreaking 36.3 megapixels and the powerful EXPEED 3 image-processing engine offer imaging potential that rivals some of the best studio cameras, but with the agility and durability of a Nikon digital SLR body. Depict the slightest change in light or shadow, on a piece of jewelry or in the glow of human skin. Still images reach a completely new height with unprecedented depth and details, both indoors and out, and this is only the beginning. Nikon's exclusive 91K-pixel RGB sensor enables the Advanced Scene Recognition System to detect human

faces even when shooting through the optical viewfinder, adding even more of an edge to your AF, AE and i-TTL flash performance. If your workflow demands broadcast quality video with high-fidelity audio recording, D-Movie will satisfy even the most demanding clients. Moreover, the D800 shoots 1080p Full HD in both FX- and DX-based formats, offering cinematographers a liberating versatility. All of this works in conjunction with outstanding mechanical precision, as well as the exceptionally sharp and versatile NIKKOR lens lineup. Turn your imagination into stunning still images and spectacular video. Create something monumental. With the D800, you can.

HIGH RESOLUTION & WIDE ISO SENSITIVITY RANGE



Nikon FX-format CMOS sensor with 36.3 effective megapixels

The D800 renders levels of texture, nuance and detail to your photography that, until now, have been the exclusive domain of the complicated medium-format system. Define every eyelash, every line in tree bark, and every shimmer of light. Savor the exceptional depth in your still images — with the astounding 36.3 effective megapixels, you can. Enlarge them as big as A1 poster-sized prints (59.4 x 84.1 cm/23.4 x 33.1 in.) at 200 dpi, or crop aggressively to reach the composition you desire, all without sacrificing the detail and tonal range of the original. In order to maintain clean, high-resolution images, 14-bit A/D conversion within the sensor and a high signal-to-noise ratio deliver phenomenal images in a diverse array of situations. The image sensor's incredible potential does not stop with photography, either. For cinematographers ready to put their exceptionally sharp NIKKOR lenses into action, the D800's 36.3 effective megapixel data is efficiently processed for exquisite 1080p broadcast quality video at 30p.

A strategic approach to turn light to your advantage

Combining both high-resolution performance and a wide ISO sensitivity range has finally become a reality. Nikon engineers have developed intelligent new methods to manipulate light transmission to the sensor's photodiodes: from the optical low-pass filter and on-chip gapless micro lenses to the image sensor's internal design, every measure has been taken to maximize and improve light transmission in order to deliver crisp, brilliant images with significantly less noise. All this is possible under a wide variety of lighting conditions, enabling you to get the most out of your NIKKOR lenses.



Standard ISO 100 to ISO 6400, range expandable to ISO 50 to 25600 equivalent

High-resolution, studio-quality images shouldn't be restricted to the studio. The D800 sets a new benchmark for high-resolution D-SLR cameras, with crisp clean images across a wide ISO range. Flexibility like this opens up new imaging opportunities for both still photographers and cinematographers alike during the "magic hour", the time just before dawn or at dusk when available light is often beautiful but scarce. Even at high ISO settings, the camera's intelligent noise reduction systems manage noise without sacrificing fine details, giving the D800 the edge. The difference can even be seen in low-contrast subjects such as hair and grass textures, which are often essential elements of cinema as well as high-resolution portraits and landscape images. High image quality at higher ISOs also means that you can shoot still images handheld more confidently, knowing that fast shutter speeds will reduce blur.

Optical low-pass filter optimized for sharpness

Reducing false color and moiré is the main job of the optical low-pass filter located in front of the image sensor. However, this benefit is generally gained with a small sacrifice of sharpness. Moiré occurs in scenes containing repetitive details, such as strong vertical lines in architecture. Finding the right balance between benefits and sacrifices is the key to higher image quality, and that is what the D800's optical low-pass filter delivers. As a result, the astounding 36.3 megapixels unleash their potential through an optimized balance between sharpness and effectively prevented moiré and false color. Furthermore, the multi-layer structure of the D800 low-pass filter utilizes layers of antireflective coating that have been optimized for the camera, contributing to sharper and clearer images.

HIGH IMAGE QUALITY & IMAGE-PROCESSING SPEED

EXPEED 3 image-processing engine: speed, versatility, and high performance



High-megapixel still images are detail-rich but data-heavy. With the D800, however, you don't have to sacrifice speed for this privilege. Dedicated to understanding speed and its role in image making, Nikon engineers designed a powerful EXPEED 3 image-processing engine exclusively for digital SLRs. From image processing and card recording to image playback and

image transfer, EXPEED 3 manages massive amounts of data at faster speeds than EXPEED 2. Even with specialized processing features like Active D-Lighting and high ISO noise reduction, capture speed is not affected. EXPEED 3 is so powerful that it handles data-intensive tasks such as Full HD video recording at 30p with ease. You'll also notice the difference in your still images and videos through minimized noise and even richer colors and tones. In addition to these fundamental advantages, the D800 reduces the kind of color phase shift that some cameras have difficulty with in similar situations.

Lateral chromatic aberration reduction: Take full advantage of your NIKKOR lens collection

High-megapixel sensors can really test the quality of your lenses, but you can be confident that the combination of brilliant NIKKOR lenses and Nikon's intelligent processing measures will significantly reduce lateral chromatic aberration to give you incredibly natural-looking results. Unlike other correction methods that simply eliminate chromatic aberration, Nikon's method compensates for these color differences in a resolving index for each color, making it particularly effective in producing images with stunning edge-to-edge sharpness. Moreover, because these corrections are made regardless of the NIKKOR lens used, this feature contributes substantially to achieving the sharpest images possible.

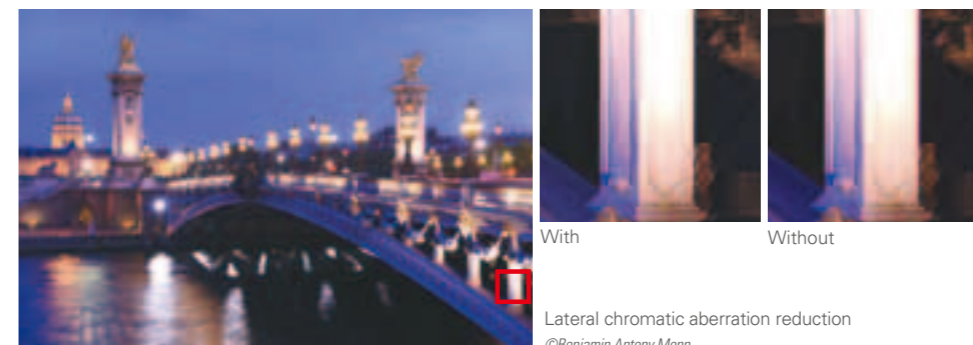

Lateral chromatic aberration reduction
©Benjamin Antony Morn



Rich tones and natural colors thanks to the EXPEED 3 image-processing engine.
• Lens: AF-S NIKKOR 24-70mm f/2.8G ED • Exposure: [A] mode, 6 second, f/8 • White balance: Auto 1
• Sensitivity: ISO 100 • Picture Control: Standard
©Jim Brandenburg

14-bit A/D conversion and 16-bit image processing for rich tones and natural colors

Tonal gradation is where an image transforms from simply representing life to taking on a life of its own. The D800 does exactly that, with cutting-edge image processing that injects vital energy into your images. Black is rendered as pitch black, and shadow details are subtle and rich. Even under harsh, high-contrast light, where some cameras can fail, the D800's gradation remains smooth with abundant detail and tone all the way up the scale to pure white.

ADVANCED SCENE RECOGNITION SYSTEM



Accurate auto exposure results, even in backlit situations, thanks to the Advanced Scene Recognition System.

• Lens: AF-S NIKKOR 70-200mm f/2.8G ED VR II • Exposure: [A] mode, 1/80 second, f/5
 • White balance: Auto 2 • Sensitivity: ISO 100 • Picture Control: Standard
 ©Cliff Mautner

Advanced Scene Recognition System with 91K-pixel RGB sensor

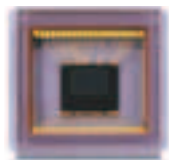

Nikon's revolutionary Advanced Scene Recognition System, introduced with the flagship D4 camera, is also employed in the D800. At its core is a 91K-pixel RGB sensor that meticulously analyzes each scene with the fine resolution. The RGB sensor can recognize your scene's colors and brightness with unprecedented precision,

then use that information to implement various automatic controls and give you more natural-looking results. The real breakthrough, however, is that the sensor can detect human faces with startling accuracy when shooting through the optical viewfinder. Along with face detection, detailed scene analysis is utilized to support more accurate autofocus, auto exposure and i-TTL flash exposure results in a diverse range of compositional and lighting situations. The improved subject tracking is most noticeable when using 3D-tracking, which can maintain a focus on moving subjects smaller in size than with previous generations.

More accurate face detection in auto-area AF and subject tracking in 3D-tracking

Auto-area AF and 3D-tracking are AF-area modes unique to Nikon that use your subject's color and brightness information to detect focus. With the D800 and its more precise information and subject recognition advancements, expect big steps forward for both AF-area modes when taking high-quality still images. In auto-area AF, the camera can genuinely detect human faces and focuses on them immediately — useful when faces are a priority and there's no time to choose focus points. When using 3D-tracking, the sensor's fine resolution combines with a specifically optimized AF algorithm to realize unprecedented subject tracking precision, recognizing detailed patterns to keep your subject in sharp focus.

3D color matrix metering III for more accurate exposures

Professional photographers who shoot still images know that Nikon's metering system delivers supremely well-balanced exposures. Thanks to the 91K-pixel RGB sensor, the D800 has far more detailed scene information at its disposal — including detected face information. This data helps the 3D color matrix metering III deliver more desirable auto exposures, especially when there are human faces present. When the D800 recognizes a human face in a backlit situation, the camera determines the overall exposure while prioritizing the facial exposure, which might otherwise be underexposed. When a face is lit from the front and appears much brighter than the background, the camera recognizes the situation and avoids blowing out the facial details.

More balanced results in i-TTL balanced fill-flash and Active D-Lighting



Nikon's i-TTL system has long been considered the most accurate flash control system in photography, but now face detection and highlight analysis by the 91K-pixel RGB sensor pushes performance even further. With the D800's enhanced i-TTL balanced fill-flash, you can more precisely illuminate people's faces in relation

to their surrounding brightness using either the built-in flash or an external hot-shoed Nikon Speedlight. For weddings and fashion shoots, or any photography that relies on the highest-quality still images, this new standard redefines what a flash system should be. Face detection also makes a difference when Active D-Lighting is used to retain highlights and shadows in high-contrast lighting situations. Faces will be optimally exposed both in the sun and in the shade.



Light source identification for auto white balance in still images

The D800's auto white balance is incredibly accurate in a diverse range of shooting situations, aided by unique Nikon technology that effectively identifies your light sources, both natural and artificial. With the 91K-pixel RGB sensor and the image sensor working together, the camera renders white as white with supreme accuracy. Or if you prefer, the auto white balance can be set to reflect the warmth of ambient, incandescent lighting.



Auto 1 to render white as pure white.
 ©Cliff Mautner



Auto 2 to render the warmth of incandescent lighting.
 ©Cliff Mautner

WIDE AF COVERAGE & IMPROVED AF SENSITIVITY

Advanced Multi-CAM 3500FX autofocus sensor module for razor-sharp detection in low light



Accurate AF detection is crucial for extremely high-resolution still images in every situation. The 51 sensor points in the D800's AF sensor module work down to -2 EV (ISO 100, 20°C/68°F), the approximate physical limit of human visibility through an optical viewfinder. For even more powerful detection, you can rely on the camera's 15 cross-type sensors in the center to detect both vertical and horizontal lines when using any AF NIKKOR lenses of f/5.6 or faster. What's more, AF can be activated with eleven focus points in the center with open aperture of f/8*, which is a big plus when you combine a telephoto lens with a 2.0x teleconverter to shoot distant subjects.

*Cross-type sensor is limited to the center AF point only. AF may not be achieved in low-contrast or low-light conditions.

Versatile AF-area modes

Whether it's a still life, a portrait, a landscape or a candid street scene, your subject matter varies, but its importance doesn't. That's why the D800 offers four AF-area modes, each specifically tailored to adapt to various subjects. Single-point AF is ideal when you need pinpoint focus on stationary subjects. Dynamic-area AF has three options (9-point, 21-point and 51-point) and is ideal for shooting moving subjects. The selected AF point and the surrounding points keep your subject in sharp focus even if it briefly leaves the selected points. 3D-tracking allows you to maintain focus on subjects that are moving erratically from side to side. Auto-area AF detects human faces and prioritizes their sharpness for you — an ideal choice for candid photography.



The D800 can autofocus your subject as low as -2 EV.
 ©Cliff Mautner

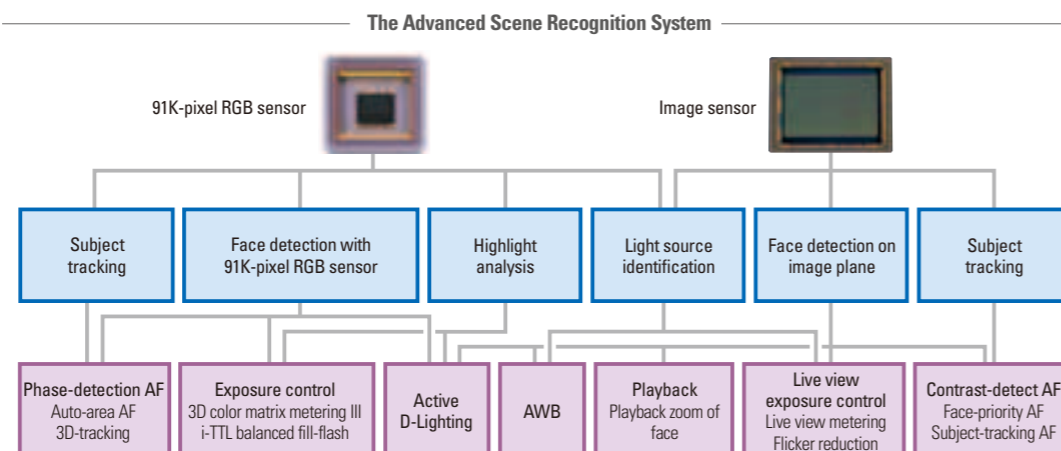



TRUE CINEMATIC EXPERIENCE

Full HD video quality and minimized rolling shutter effect: Dynamic movie shooting in diverse lighting situations

Many filmmakers, multimedia professionals and still photographers need the highly mobile, lightweight and compact form of a D-SLR in order to cover large events or make documentaries, music videos or movies. For these professionals, the D800 is ready to create true cinematic experiences. By using the B frame data compression method, you can record 1080p Full HD video at 30p in H.264/MPEG-4 AVC format with unmatched moving image integrity for up to 29 min. 59 s* of recording in a single clip. Thanks to Nikon's latest image-processing optimizations, the monumental power of 36.3 megapixels transforms to sharp, exquisitely rendered videos. Expect exceptionally smooth gradation in blue skies, with minimum block noise and beautifully natural movement rendered clearly and sharply. The D800's intelligent image sensor reads out movie images at faster rates than ever, significantly reducing the rolling shutter distortion that can occur during panning shots or when shooting fast-moving lateral subjects like trains. Thanks to EXPEED 3, your movies will take on a distinctive look of their own, even with dimly lit scenes. Combine these benefits and you'll begin to realize exactly the new creative opportunities possible for photographers and cinematographers alike.

*Maximum recording time varies according to frame rate, frame size and image quality settings. Maximum recording time for time-lapse photography is 20 min.

Frame size and frame rate

Frame size	Frame rate	Frame size	Frame rate
1,920 x 1,080	30p (29.97 fps)	1,280 x 720	60p (59.94 fps)
	25p (25 fps)		50p (50 fps)
	24p (23.976 fps)		30p (29.97 fps)
			25p (25 fps)

Note: Options support both high and normal image quality.

Multi-area mode Full HD D-Movie: Creative movie-making freedom in FX- and DX-based formats

The D800 is designed to stimulate cinematographers to explore different moods and perspectives by enabling Full HD and HD video recording in two frame formats; Nikon FX- and DX-based movie formats in just one camera. When using wide-aperture NIKKOR lenses, the large image area of the FX-based format* renders exquisitely shallow depth of field with beautiful bokeh effects. The DX-based format uses an image area similar to 35mm movie film, allowing cinematographers to shoot with picture angles that they are accustomed to. Having the advantage of two D-Movie formats in one camera and an arsenal of NIKKOR lenses makes the D800 an incredibly versatile movie-making tool.

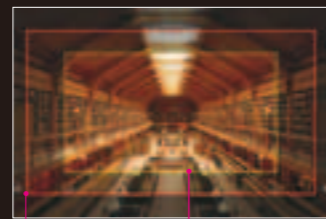

*The aspect ratio of movies is 16:9 whichever format is selected. Also, in the FX-based movie format, the width of the image area is approx. 91% of that in the still image FX format.

Smoother video recording under fluorescent or mercury lamps: Auto flicker reduction

With the D800, it is easier than ever to reduce flicker effects during live view and video recording. Simply use auto in the flicker reduction menu to automatically identify the flicker frequency at the beginning of live view and switch to the one that will work best. You can also manually switch between 50 Hz and 60 Hz.

INTEGRATED OPERATION

Live view selector for optimized still images and movies



The D800's live view operation has evolved even further, optimizing camera control to become more intuitive for shooting video as well as still images. Simply clicking the live view selector switches between live view modes

designed specifically for still images or movies. Live view photography lets you shoot still images while confirming the exposure level on the LCD monitor*. You can even magnify images up to approx. 23x to check the exact focus. For movie live view on the other hand, the D800 incorporates a dedicated exposure control for quality video shooting, enabling smooth exposure transition when shooting moving subjects. You can also shoot video with full manual control. When needed, press the shutter-release button while filming to instantly capture still images in 16:9 aspect ratio. Each time you use live view, for either still photography or movie shooting, your image area and camera setting information will be clearly indicated, allowing you to confirm quickly.

*Exposure preview display and resulting image may vary, depending on the settings used.

View simultaneous live view output on external monitors and record uncompressed video via HDMI

During movie shooting, you can now simultaneously check videos on an external monitor* using an HDMI connection, in addition to the camera's TFT monitor. And for those who need the purest video output for professional quality editing, you can now record uncompressed movie live view footage directly to an external storage device via HDMI interface.

*When video is output through HDMI interface simultaneously with recording to a CF/SD card, output image through HDMI interface will be smaller than 1,280 x 720.



HDMI
HIGH-DEFINITION MULTIMEDIA INTERFACE

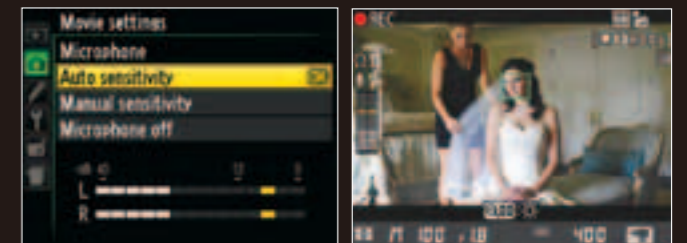

Audio levels can be visually confirmed — both before and during movie shooting.

Comprehensive high-fidelity audio recording control

The D800 is designed for crisp stereo recording with a built-in external stereo microphone input. Attach the compact ME-1 Stereo Microphone to record clear sound while significantly reducing mechanical noise. An external headphone jack enables you to effectively monitor and control audio in isolation. While the audio level indicators offer visual confirmation of audio level, the microphone sensitivity can be controlled precisely in 20 incremental steps.

Time-lapse photography

Capture a variety of scenes and subjects at a breathtaking pace. The D800's time-lapse photography lets you set intervals and frame rates in order to dramatically relay slow-moving activity at dramatic speeds. The D800 allows you to shoot time-lapse photography with replaying rates from 24 times to 36,000 times faster than normal. Time-lapse photography files can be saved as a movie file.

Note: Movie files of time-lapse photography will be saved in 16:9 aspect ratio. It is recommended to confirm image area in movie live view before starting time-lapse photography.

Versatile custom settings for D-Movie

The D800 has addressed useful feedback from videographers with convenient custom controls for D-Movie operation. Instead of rotating the command dial, power aperture enables smoother aperture controls during movie live view using a button designated via custom menu, which can be very convenient to confirm depth of field. Index marking helps you locate important frames for later-stage in-camera editing and replay by attaching markers during movie recording. Markings are indicated along with the timeline, which is easy to confirm visually.

VISION YOU CAN DEPEND ON

Glass prism optical viewfinder with approximately 100% frame coverage

See every important element in your frame clearly and precisely. The D800 offers approx. 100% frame coverage (in FX format) from its slim pentaprism, giving you the visually comfortable FX-format advantage and an unobstructed view when shooting still images. The viewfinder image is not only large and bright — the focusing screen is also carefully designed to help you sense sharp focus intuitively, be it manual or autofocus.



Precision 8-cm (3.2-in.), approx. 921k-dot, wide-viewing-angle LCD monitor with automatic monitor brightness control

The D800's large and sharp color LCD monitor delivers bright, crisp image playback with a much larger capacity for accurate color reproduction. Using an antireflective structure, you can count on clarity equal to that of the D4, even under bright conditions. Moreover, if monitor brightness is set to "Auto", the camera automatically adjusts LCD brightness according to the environmental lighting conditions measured by the ambient brightness sensor, allowing easy use of live view in both bright and low-lit places — very useful when shooting video and stills. The ability to magnify playback images up to 46x (Large-size images in FX format) is extremely helpful for spot focus confirmation.

LCD monitor with an integrated structure of glass and panel realizes a clearer image

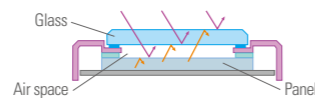

Conventional models

Air space between glass and panel causes reflections at the surfaces of each part, resulting in some light loss.

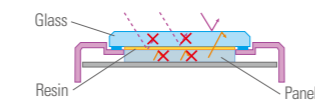

D800

Surface reflection is reduced and light loss greatly decreased by the integrated structure of glass and panel.



Ambient brightness sensor
©Jim Brandenburg

READY FOR DEMANDING TASKS

Lightweight yet durable construction

Many important parts of the D800 have been designed to achieve better durability and lighter weight. The result is a camera approx. 10% lighter than the D700, yet just as rugged. A magnesium alloy construction protects the sophisticated technologies against accidental shock, and weather and dust sealing has been extensively applied and severely tested, making the D800 as reliable on the road as it is in the studio.

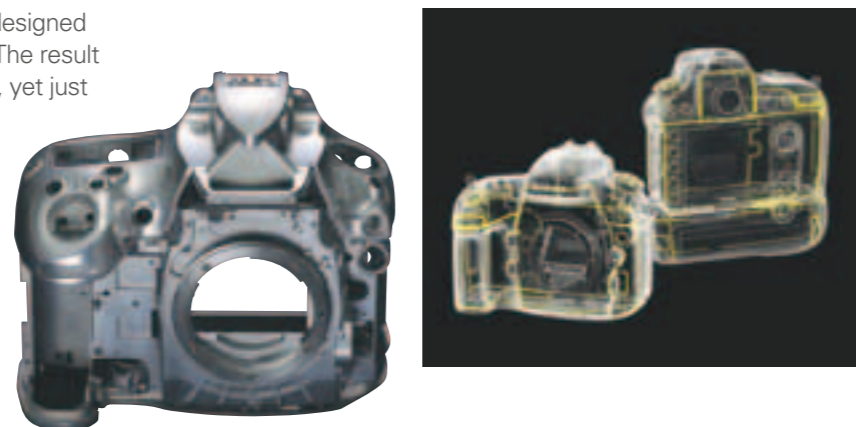

Fast response time

The D800 is designed to respond immediately. Once the strategically located switch is turned on, the camera starts up in approx. 0.12 seconds* and your finger is in position for shutter release. Release time lag is minimized to approx. 0.042 seconds*, equivalent to that of the D3S, with continuous approx. 4 fps capability in FX format, approx. 5 fps in 1.2x and DX format and approx. 6 fps capability in DX format** with MB-D12.

*Based on CIPA Guidelines.

**When used together with batteries other than EN-EL15.

High-speed CF and SD dual card slots

Card recording speed is yet another crucial element of a smooth and productive shooting experience. The D800 CF memory card slot is compatible with the latest UDMA 7. The SD card slot is compatible with SDXC (Secure Digital eXtended Capacity) and UHS-I. You can also use two cards simultaneously for a number of functions, such as recording JPEG and RAW data on separate cards, recording the same data simultaneously on two cards for backup and more.



High-speed data transfer with USB 3.0



For a more productive tethered and transfer workflow, the D800 is compatible with USB 3.0. When connected to equipment featuring USB 2.0, speed is reduced to that of USB 2.0.

High-precision, high-durability shutter

The D800's shutter unit has been tested to well over 200,000 cycles of release to prove durability and precision. While the shutter unit designed to run at a speed range of 1/8,000 to 30 s, its intelligent self-diagnostic shutter monitor automatically monitors actual shutter speeds in order to correct possible variances that can occur over time.



High-precision sequential control mechanism

For true digital SLR excellence, the camera's mechanical structure, power and precision are vital to ensure indispensable speed and reliability. That's why Nikon utilized its engineering expertise to refine the powerful sequential control mechanism that drives the shutter, mirror, and aperture independently. As a result, shutter release can be operated with mirror-up position during live view. Because mirror-down movement is not required, you can expect even quieter still live view shooting. And as power aperture control operates via the stepping motor, the sound of mechanical adjustment is reduced for quieter and smoother control.



Efficient power management

A comprehensive re-working of the D800's circuits now enables approx. 900 shots* of still image shooting. All on one charge of an EN-EL15 Rechargeable Li-ion Battery.

*Based on CIPA Standards.



MB-D12 Multi-Power Battery Pack (optional)

Attach the MB-D12 to the camera body to extend battery stamina. The pack accommodates a variety of batteries (see specifications) and utilizes the same integral magnesium alloy construction and weather sealing as the D800 body itself. You also get approx. 6 fps continuous shooting speed* in DX format. The MB-D12 has its own dedicated shutter-release button and command dials for vertical composition shooting.

*When using batteries other than EN-EL15 Rechargeable Li-ion Battery.



CONNECTING HANDS, EYES AND IDEAS

Improvements around the shutter-release button

Angle, shape, contour, and texture: all of these design facets came into play when crafting the D800's shutter-release button. Your index finger can rest comfortably for longer periods of time, allowing you to concentrate when it matters, while the designated movie-record button means you're ready to trigger movie shooting in an instant.



Direct access to Picture Control

Customize the look of your stills and videos through Picture Controls by fine-tuning parameters such as sharpening, saturation, and hue. The D800 now allows you to access Picture Control instantly and directly from a dedicated button rather than entering the menu. When live view shooting, you can visually confirm how customized Picture Control settings will look and easily adjust the parameters.



Picture Control button

Choosing AF mode and AF-area mode combinations

Control your desired AF mode (continuous or single servo) and AF-area mode (single-point, dynamic-area, 3D-tracking or auto-area AF) without ever taking your eye away from the viewfinder. By using a dedicated AF-mode button and command dials, you can switch between modes without interrupting your creative flow.



Four-button layout and release mode dial on the camera's top deck

Important camera settings can be controlled and adjusted from buttons placed on the top deck. Along with dedicated buttons for ISO, white balance and image quality, a new bracketing button has been strategically placed to aid such features as HDR. In addition, the release mode dial also improves mode visibility and operability.



CREATIVE EXPANSION TOOLS

Expand dynamic range: HDR (High Dynamic Range)

The D800 can shoot two frames in a single shutter release, but at different exposures: one overexposed and one underexposed. The camera then instantly combines them to create an image covering a wider dynamic range. The range can be widened by up to 3 EV for different looks, all full of saturation and tonal gradation, while the smoothness of the edge where the two exposures meet can be adjusted for a more natural appearance.



Note: Tripod use is recommended.

Accurate confirmation of level shooting: Dual-axis electronic virtual horizon

With the D800, you can always check the LCD monitor or the viewfinder for both the camera's position in relation to the horizontal plane and its pitch (forward or rear rotation). This can enhance compositional accuracy, particularly when shooting still lifes, landscapes and architecture.



LCD monitor display

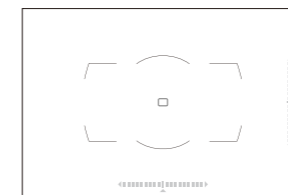

Viewfinder display

Shoot achieving reduced blur with zoom lenses in dim light: Auto shutter speed control for auto ISO sensitivity control

The D800 comes equipped with an auto option for minimum shutter speed that automatically controls the balance between shutter speed and the ISO sensitivity based on the focal length of the lens being used. This can be particularly useful when using a zoom lens, because the camera can automatically choose the shutter speed to reduce camera shake. What's more, through the operation of ISO button and sub-command dial, auto ISO sensitivity control can be immediately turned on or off, without needing to enter the menu.

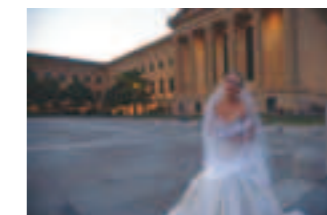

• Shutter speed: 1/25 second • Aperture: f/4
• Focal length: 24mm • Sensitivity: Auto (ISO 900)
©Cliff Mautner

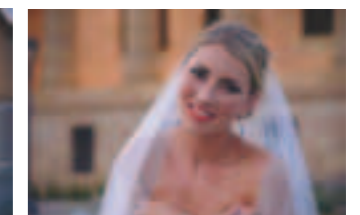

• Shutter speed: 1/100 second • Aperture: f/4
• Focal length: 120mm • Sensitivity: Auto (ISO 6400)
©Cliff Mautner

Shoot with multiple formats in one camera: Image area options

The D800 offers four image area options: FX format (35.9 x 24.0 mm), 5:4 (30.0 x 24.0 mm), 1.2x (30.0 x 19.9 mm), and DX format (23.4 x 15.6 mm) with all cropped image areas visually masked in the viewfinder. DX format offers approx. 1.5x, and 1.2x crop offers approx. 1.2x telephoto effect. When a DX NIKKOR lens is used, DX format is automatically selected.

Refined color temperature control: Minute control over white balance

The D800's white balance proves its reliability even when using an external flash and live view in the studio environment. The monitor hue of live view and resulting image's white balance can be individually set so that the difference between the two is minimized. Furthermore, for even more control, color temperature can be manually set in 10-kelvin increments or in mired units.



Image enhancement options: In-camera editing

Captured images and movies can be altered and edited in-camera and on the fly if required, all without the need to resort to a computer. Retouch menus include an array of useful features such as NEF (RAW) processing, resize, distortion control, fisheye, miniature effect, red-eye correction, filter effects and image overlay, as well as the ability to designate the start and end point of movie clips all at once, in order to save them more efficiently.



The defining strength to match outstanding resolution for stills and videos



The wide range of sharp and accurate NIKKOR lenses can handle nearly any professional need.
 © Benjamin Antony Monn
 Admont Benedictine Monastery Library
 • Lens: AF-S NIKKOR 14-24mm f/2.8G ED • Exposure: [M] mode, 1/2 second, f/8 • White balance: Color temperature (5,000 K) • Sensitivity: ISO 100 • Picture Control: Standard

To best draw out the full potential that a 36.3 megapixel camera can offer, lens quality is of vital importance. Even subtle differences in optical performance make a difference when utilizing such a large pixel count. NIKKOR empowers photographers and cinematographers in every field, allowing them to better see the essence of their vision and render it as sharp as possible without sacrificing delicate tones or nuance. From f/1.4 primes to fast f/2.8 zooms to f/4 zooms with VR, the latest line of NIKKOR lenses — many loaded with the renowned Nano Crystal Coat — is fully optimized to deliver the image quality the Nikon D800 truly deserves. Moreover, DX lenses can also be used for the D800: simply attach one and the camera automatically recognizes it and sets the required crop.

Get studio quality lighting virtually anywhere



The Advanced Wireless Lighting System, using three groups of Nikon Speedlights.
 © Rob Van Petten
 • Lens: AF-S NIKKOR 24mm f/1.4G ED • Exposure: [M] mode, 1/2 second, f/8 • White balance: Auto 1 • Sensitivity: ISO 800 • Picture Control: Portrait

Fast, versatile and portable, with Nikon Speedlights in your hands, your lighting possibilities are endless. The difference is a level of accuracy and flexibility that only the Nikon Creative Lighting System delivers. Its advantages are best experienced via Advanced Wireless Lighting. Using high-precision i-TTL flash control with strategic, intuitive operations, you can make lighting as powerful and comprehensive as your imagination can take it. Whether you shoot in the studio or in far-flung locations, there is a Nikon Speedlight solution to inspire your creativity.

Unparalleled lighting performance — SB-910 Speedlight

Nikon's SB-910 offers versatile i-TTL for on-camera or wireless flash control, a refined operability and a powerful guide number of 34/111.5 (ISO 100, m/ft, STD, FX format with zoom head set at 35mm). The SB-910's menus and controls have been improved for more operational ease. When a hard-type incandescent or fluorescent color filter is attached, the SB-910 detects it and adjusts white balance instantly.



SB-700

SB-400

D800 with R1C1



75 million NIKKOR

Comprehensive approach for managing 36.3 MP files

Capture NX 2 (optional): Optimal for processing images taken with the D800

To accommodate the imaging power of the D800's 36.3 effective megapixels, the latest Capture NX 2 now features powerful 64-bit processing. Capture NX 2 drastically simplifies an array of image enhancement procedures, letting you concentrate on making your pictures the best they can be. Instead of complicated layering and memorization, simply place a Color Control Point wherever you want to reprocess. Color Control Points use intuitive slider controls to make quick and easy adjustments to image characteristics such as brightness, contrast, saturation and tones. Change, adjust and experiment all you like, safe in the knowledge that all changes are non-destructive and an original always remains intact.



Capture NX 2

ViewNX 2: Browse, edit, share and more

This bundled, all-in-one software implements an easy-to-use interface for all your photos and movies. Take advantage of an array of editing functions, including basic editing of RAW files and even D-Movies. ViewNX 2 also works effortlessly with Nikon's photo-sharing and storage service, NIKON IMAGE SPACE, with labels to help you find that special photo quickly and easily.



ViewNX 2

Camera Control Pro 2 (optional): Extremely versatile remote camera controls

For those that want to operate their camera via computer, Camera Control Pro 2 lets you control camera settings and various features from a distance. Aside from controlling exposure mode, shutter speed, and aperture, the software now offers numerous improvements to make the D800's live view operation exceptionally smooth. Creative control opportunities include remote start and stop for movie shooting and switching between live view for stills and movies. You can also adjust the monitor hue of live view photography and the resulting image's white balance individually, which can be quite helpful when working in the studio. You can also display audio level indicators during movie shooting. And with the optional Wireless Transmitter WT-4A/B/C/D/E, image files can be transferred using either Wi-Fi or an Ethernet connection.

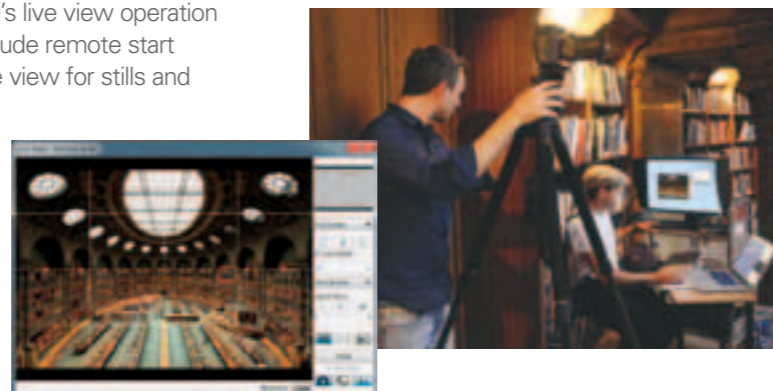

Camera Control Pro 2

D800E The ultimate attention to detail

Nikon engineers have developed a unique alternative for those seeking the ultimate in definition. The D800E incorporates an optical filter with all the anti-aliasing properties removed in order to facilitate the sharpest images possible.

This is an ideal tool for photographers who can control light, distance and their subjects to the degree where they can mitigate the occurrence of moiré. Aside from the optical filter, all functions and features are the same as on the D800.

Note: The D800E carries an increased possibility that moiré and false color will appear, compared to the D800. IR cut and antireflective coating properties of the optical filter remain the same with both versions.

For further details, please visit Nikon's website.

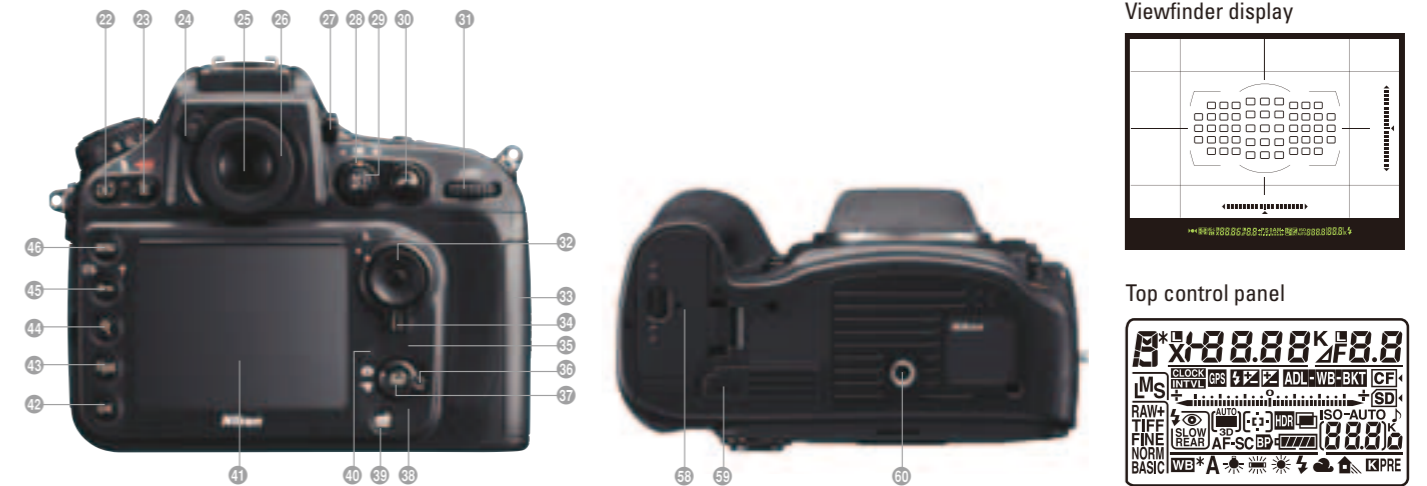

Viewfinder display

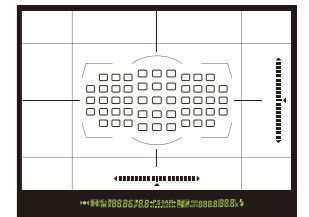

Top control panel

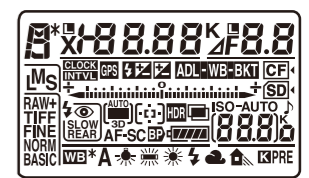

- 1 Power switch
- 2 Eyelet for camera strap
- 3 Shutter-release button
- 4 AF-assist illuminator/Self-timer lamp/Red-eye reduction lamp
- 5 Lens mount
- 6 Built-in flash
- 7 Mirror
- 8 Flash pop-up button
- 9 Built-in microphone
- 10 Release mode dial lock release
- 11 Flash sync terminal cover
- 12 Flash mode button/Flash compensation button
- 13 Mounting index
- 14 Ten-pin remote terminal cover
- 15 Meter coupling lever
- 16 Lens release button
- 17 AF-mode button
- 18 Focus-mode selector
- 19 Fn button
- 20 Depth-of-field preview button
- 21 Sub-command dial
- 22 Playback button
- 23 Delete button/Formatting memory cards button
- 24 Eyepiece shutter lever
- 25 Viewfinder
- 26 Viewfinder eyepiece
- 27 Diopter adjustment control
- 28 Metering selector
- 29 AE/AF lock button
- 30 AF-ON button
- 31 Main command dial
- 32 Multi selector
- 33 Memory card slot cover
- 34 Focus selector lock
- 35 Speaker
- 36 Live view selector
- 37 Live view button
- 38 Memory card access lamp
- 39 Info button
- 40 Ambient brightness sensor for automatic monitor brightness control
- 41 Monitor
- 42 OK button
- 43 Thumbnail button/Playback zoom out button
- 44 Playback zoom in button
- 45 Protect button/Help button/Picture Control button
- 46 Menu button
- 47 Image quality button/Image size button/Two-button reset button
- 48 Release mode dial
- 49 Control panel
- 50 Exposure mode button/Formatting memory cards button
- 51 Movie-record button
- 52 Exposure compensation button/Two-button reset button
- 53 Focal plane mark
- 54 Accessory shoe (for optional flash unit)
- 55 Bracketing button
- 56 ISO sensitivity button/Auto ISO sensitivity control button
- 57 White balance button
- 58 Battery-chamber cover
- 59 Contact cover for optional MB-D12
- 60 Tripod socket
- 61 Connector cover
- 62 Connector for external microphone
- 63 USB connector
- 64 Headphone connector
- 65 HDMI mini-pin connector

The D800 On Assignment

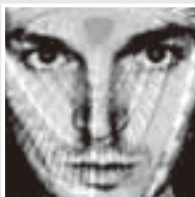

Benjamin Antony Monn
Fine art/Architecture (Germany)

As a modern architectural photographer I am always looking for a lightweight, compact and reliable camera system fulfilling the requirements of my personal artistic and client expectations. The Nikon D800 will set new standards for the high-end 35mm D-SLR market. I have never worked with a 35mm digital camera that produces images with such exceptional quality and detail till now. Particularly, the live view mode enables extremely precise compositions and easy focusing in dim lighting, which simplifies my workflow. Superior quality lenses such as the PC NIKKOR tilt & shift lineup are indispensable for architectural photography. From my hands-on experience I found that they perfectly match with the newly invented system and produce breathtakingly clean, clear and sharp files. This camera gives me the photographic flexibility to work at unusual shooting locations and capture images in an exceptional range of light. It definitely takes my photographic versatility and image quality to a new level. What a new companion!

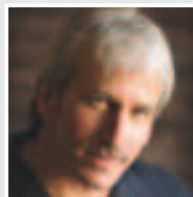

Cliff Mautner
Wedding (U.S.A.)

Speed and power, without compromise. That's how I'd sum up my impression of the new Nikon D800. Established medium-format image quality is now inside a phenomenal, incredibly responsive Nikon machine. At 36.3 megapixels, the D800 produces unprecedented image quality and resolution within a body that boasts revolutionary technological advances. The 3D color matrix metering III, wide dynamic range and the improved AF performance in low light are just a few features that are glaring improvements. The D800 allows me to concentrate on the light, the composition and my subject without having to think about much else. In years past, wedding photography was traditionally captured with medium-format equipment for maximum image quality. When the 35mm format was adopted within the genre, it was widely accepted that image quality was compromised in lieu of speed and convenience. Now, my wedding portraiture will have a depth it's never shown before, and my style of shooting will be enhanced rather than compromised, thanks to the D800.

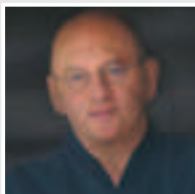

Jim Brandenburg
Nature (U.S.A.)

To me, cameras are more like paintbrushes than technology. The goal is not megapixels or technique but the image, and while camera models are important, they are not the be-all or end-all. But after a lifetime using countless cameras, I have found a new best friend. It was not love at first sight. The sharpness and detail were initially intimidating, exposing my flaws like never before. Subtle camera movements showed and differences of acuity between aperture choices on various lenses were apparent. But now I am enthralled with this technology. Why? Because the images almost feel as though they were made with a 4x5 view camera! Special features like time-lapse photography and the improved HD video quality and flexibility also add tremendously to the camera's personality. After spending a month with the D800, I'll never be the same again. Perhaps the best compliment I can express is that now I will think differently about the images I make.

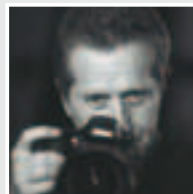

Rob Van Petten
Fashion (U.S.A.)

When I'm shooting beauty and jewelry in the studio or fashion on location, 36.3 megapixels changes the industry standard: in image quality, dynamic range, color rendering and the final print. The detail from the D800 produces the look of a medium-format camera, but gives me the feel and response of a D-SLR. The improvements in rendering skin tone and specular highlights, as well as fabric and hair detail are superior to anything that has come before. Autofocus quickly tracks models in motion. Nikon's 91K-pixel RGB sensor has noticeable improvements in metering accuracy, while the larger LCD is easier to read. The camera body feels solid and ergonomically simple, while also feeling lighter and smaller than previous high-resolution Nikons. New cameras always inspire me to test and explore, and all the useful features in such a compact package will open huge creative possibilities for my high-quality prints and video.

Specifications and equipment are subject to change without any notice or obligation on the part of the manufacturer. May 2013
©2013 Nikon Corporation Nikon symbol is a registered trademark of Nikon Corporation in Japan and the USA.



WARNING

**TO ENSURE CORRECT USAGE, READ MANUALS CAREFULLY BEFORE USING YOUR EQUIPMENT.
SOME DOCUMENTATION IS SUPPLIED ON CD-ROM ONLY.**



Nikon Canada Inc. 1366 Aerowood Drive, Mississauga, Ontario, L4W 1C1, Canada www.nikon.ca
Nikon Inc. 1300 Walt Whitman Road, Melville, N.Y. 11747-3064, U.S.A. www.nikonusa.com